

This Copy is a reprint which includes current pages from Change 1.

OPERATOR'S MANUAL

Approved for public release; distribution is unlimited.

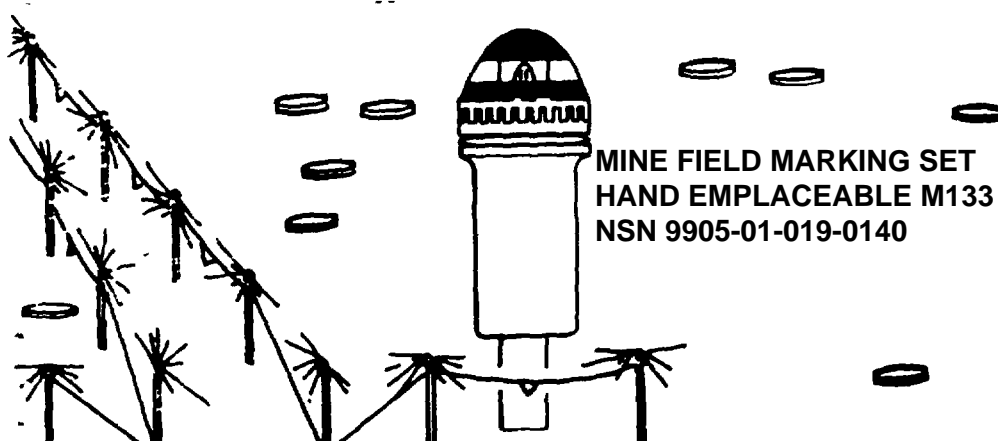

3 JULY 1992

This manual supersedes TM 5-9905-200-10 dated 1 August 1979

CHANGE

NO. 2

HEADQUARTERS
DEPARTMENT OF THE ARMY
WASHINGTON D.C., 30 September 1996

OPERATOR'S MANUAL

MINE FIELD MARKING SET
HAND EMPLACEABLE M133
NSN 9905-01-019-0140

DISTRIBUTION STATEMENT A: Approved for public release; distribution is unlimited.

TM 5-9905-200-10, 3 July 1992,
is changed as follows:

1. Remove and insert pages as indicated below. New or changed text material is indicated by a vertical bar in the margin. An illustration change is indicated by a miniature pointing hand.

Remove pages

Insert pages

1-3 and 1-4
2-29 and 2-30

1-3 and 1-4
2-29 and 2-30

2. Retain this sheet in front of manual for reference purposes.

By Order of the Secretary of the Army:

Official:

JOEL B. HUDSON
*Administrative Assistant to the
Secretary of the Army*
02502

DENNIS J. REIMER
*General, United States Army
Chief of Staff*

DISTRIBUTION:

To be distributed in accordance with DA Form 12-25-E, block no. 1189,
requirements for TM 5-9905-200-10.

CHANGE

NO. 1

HEADQUARTERS
DEPARTMENT OF THE ARMY
WASHINGTON D.C., 18 January 1994

OPERATOR'S MANUAL

MINE FIELD MARKING SET
HAND EMPLACEABLE M133
NSN 9905-01-019-0140

DISTRIBUTION STATEMENT A: Approved for public release; distribution is unlimited.

TM 5-9905-200-10, 3 July 1992,
is changed as follows:

1. Remove and insert pages as indicated below. New or changed text material is indicated by a vertical bar in the margin. An illustration change is indicated by a miniature pointing hand.

Remove pages

Insert pages

i and ii

i and ii

1-1 and 1-2

1-1 and 1-2

B-7 through B-10

B-7 through B-10

2. Retain this sheet in front of manual for reference purposes.

By Order of the Secretary of the Army:

Official:

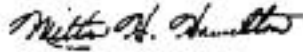

MILTON H. HAMILTON
*Administrative Assistant to the
Secretary of the Army*

06154

GORDON R. SULLIVAN
*General, United States Army
Chief of Staff*

DISTRIBUTION:

To be distributed in accordance with DA Form 12-25-E, block no. 1189, requirements for TM 5-9905-200-10.

* GPO: 1996 - 406-421 (60101)

WARNING

DEATH or SERIOUS injury may result if personnel fail to observe safety precautions.

Do not drop set from bed of truck.

Never stand or place pole within 66 feet (20 meters) of emplaced mine.

Exercise care when removing poles from pole bag so as not to hit anyone with points.

Do not throw poles.

Do not retrieve set around a scatterable minefield during the period when mines may self destruct.

Use drive plate when driving poles into ground to prevent damaging pole driver.

When emplacing the tape, never walk backwards to the next pole.

Do not jump on, or place both feet on pole driver when pushing poles into the ground.

a/(b blank)

HEADQUARTERS
DEPARTMENT OF THE ARMY
WASHINGTON D.C., 3 July 1992

OPERATOR'S MANUAL
MINE FIELD MARKING SET
HAND EMPLACEABLE M133
NSN 9905-01-019-0140

REPORTING OF ERRORS

You can help improve this manual. If you find any mistakes or if you know of a way to improve the procedures please let us know. Mail your DA Form 2028 (Recommended Changes to Publications and Blank Forms) directly to Commander, US Army Aviation and Troop Command., ATIN: AMSAT-I-MP, 4300 Goodfellow Blvd., St. Louis, MO 63120-1798. A reply will be furnished to you.

Distribution Statement A. Approved for public release; distribution is unlimited.

Change 1 i

TABLE OF CONTENTS

CHAPTER 1.	INTRODUCTION	1-1
Section I.	General Information	1-1
Section II.	Equipment Description	1-2
CHAPTER 2.	OPERATING INSTRUCTIONS	2-1
Section I.	Preventive Maintenance Checks and Services (PMCS)	2-1
Section II.	Operation under Usual Conditions	2-6
Section III.	Operation under Unusual Conditions	2-32
CHAPTER 3.	MAINTENANCE INSTRUCTIONS	3-1
APPENDIX A.	REFERENCES	A-1
APPENDIX B.	COMPONENTS OF END ITEM	B-1
APPENDIX C.	EXPENDABLE/DURABLE SUPPLIES AND MATERIALS LIST	C-1

CHAPTER 1

INTRODUCTION

SECTION I. GENERAL INFORMATION

1-1. SCOPE. This Operator's Manual provides instructions for the operation and maintenance of the Hand Emplaceable Minefield Marking Set (HEMMS) M1 33, NSN 9905-01-019-0140. HEMMS is a means of guiding friendly forces safely through or around our own scatterable or conventional minefields.

1-2. MAINTENANCE FORMS AND RECORDS. Department of the Army forms and procedures used for equipment maintenance will be those prescribed by TM 38-750, The Army Maintenance Management System (TAMMS).

1-3. REPORTING EQUIPMENT IMPROVEMENT RECOMMENDATIONS (EIR'S). EIR's can and must be submitted by anyone who is aware of an unsatisfactory condition with the equipment design or use. It is not necessary to show a new design or list a better way to perform a procedure, just simply tell why the design is unfavorable or why a procedure is difficult. EIR's may be submitted on SF 368 (Quality Deficiency Report) in accordance with TM 38-750. Mail directly to Commander. US Army Aviation and Troop Command, ATTN: AMSAT-I-MDO, 4300 Goodfellow Blvd., St. Louis, MO 63120-1798. A reply will be furnished to you.

Change 1 1-1

SECTION II. EQUIPMENT DESCRIPTION

1-4. EQUIPMENT PURPOSE, CAPABILITIES AND FEATURES.

a. The Hand Emplaceable Minefield Marking Set (HEMMS) is a means of guiding friendly forces safely through or around our own scatterable or conventional minefields. It consists of a line of poles containing flashing lights connected by fluorescent orange tape. The marking set will be placed around minefield perimeters and safe lanes.

b. The set will be used to temporarily mark conventional indefinite life minefields emplaced by the M57 Anti-Tank Mine Dispensing System. The set could also be used to temporarily mark other indefinite life minefields. However if these minefields are to be left in place longer than 15 days, the HEMMS should be replaced with Minefield Marking Set Number 2 when time becomes available.

c. Each Minefield Marking Set is capable of marking 2300 to 3300 feet (700 to 1000 m) of minefield and safe lane perimeter if the average pole spacing is no less than 33 feet (10 m).

d. The poles are placed 33 to 49 feet (10 to 15 m) apart, except those poles adjacent to corner poles which are spaced 13 feet (4 m) from the corner pole.

e. Pole positioning depends on topography, soil condition, and wind velocity.

f. The poles are joined together with fluorescent orange tape to form a restrictive fence.

g. Sets should be recovered and reused.

5. LOCATION AND DESCRIPTION OF MAJOR COMPONENTS.

a. COMPONENTS OF SETS.

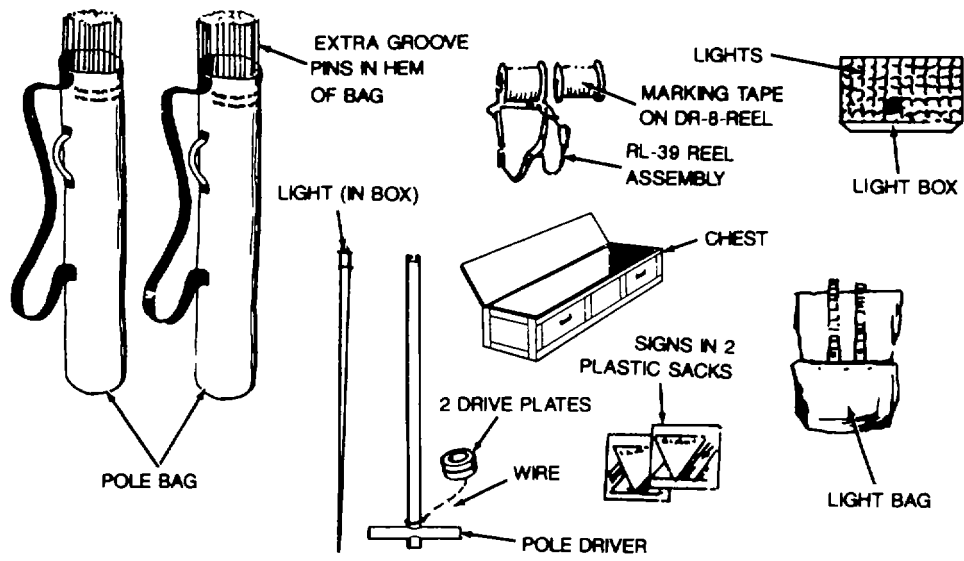

b. QUANTITIES AND WEIGHTS OF INDIVIDUAL SET COMPONENTS.

<u>DESCRIPTION</u>	<u>QUANTITY</u>	<u>WEIGHT EACH (POUNDS)</u>	<u>WEIGHT TOTAL (POUNDS)</u>
Lights	72	0.33 (0.150 kg)	23.4 (10.6 kg)
Poles	70	0.82 (0.372 kg)	57.7 (26.2 kg)
Marking Tape	7200 Ft (2196 m)		15.3 (6.9 kg)
Reels, DR-8	2	2.49 (1.13 kg)	5.0 (2.3 kg)
Pole Driver	1	3.67 (1.67 kg)	3.67 (1.67 kg)
Reel Assembly, RL-39	1	2.71 (1.23 kg)	2.71 (1.23 kg)
Light Box	1	3.00 (1.36 kg)	3.00 (1.36 kg)
Vapor Proof Bag	1	0.46 (0.21 kg)	0.46 (0.21 kg)
Light Bag	2	3.00 (1.36 kg)	6.00 (2.72 kg)
Pole Bags	2	1.06 (0.48 kg)	2.12 (0.96 kg)
Chest	1	52.90 (24.0 kg)	52.90 (24.0 kg)
Drive Plate	2	0.11 (0.05 kg)	0.11 (0.10 kg)
Wire to drive plate	1	0.01 (0.005 kg)	0.01 (0.005 kg)
■ Packing - Internal	AR	1.63 (0.74 kg)	1.63 (0.74 kg)
■ Signs	70	0.03 (0.014 kg)	2.00 (0.91 kg)
■ Operator's Manual	1	0.07 (0.03 kg)	0.07 (0.03 kg)
TOTAL WEIGHT - FULLY PACKED SET			174.1 (78.97 kg)

Change 2 1-4

c. **DRIVE PLATES** There are two drive plates in each set. They fit down over the pole and rest on the groove pin, protecting the pole driver from peening when driving poles.



DRIVE PLATE

d. **POLES** The poles are made of aluminum tubing secured to a steel point by a steel groove pin. The top of the tubing is slotted.

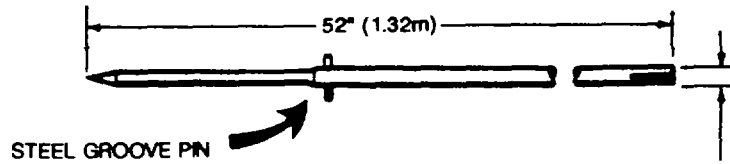

POLE

e. **POLE DRIVER** The pole driver is made of steel tubing with an inside diameter large enough to slide over the

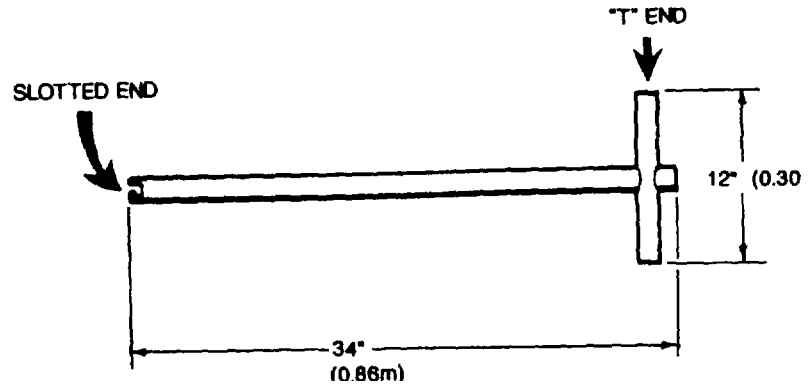

1-6

f. LIGHT.

The light is 6 inches (162.4 mm) long and 2 inches (50.8 mm) in diameter. It has an orange neon lamp which initially flashes about 82 flashes per minute. As the battery becomes used the flash rate decrease. The flash rate is also reduced by low temperatures. A light shield inside the dome of the flasher prevents the light from being seen directly overhead. A reflector behind the neon lamp directs the light so that it can be seen from only one direction. The outside of the plastic case has a reflective surface to make it visible in light from vehicle headlights.

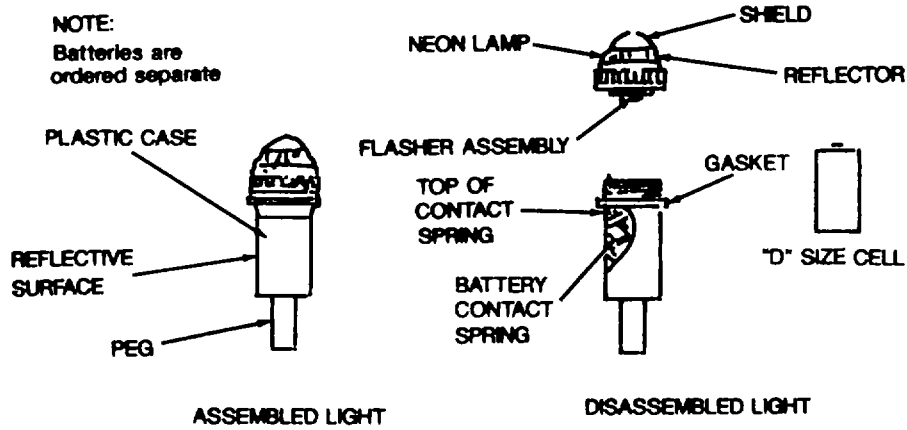

g. DR-8 REEL. The DR-8 reel is painted olive drab. 3600 feet (1096 cm) of fluorescent orange tape is wound on each reel.

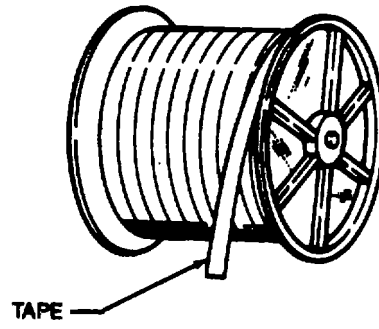

1-8

h. POLE BAG. The pole bag is used to carry 36 pole. It is carried over the shoulder. There are two extra groove pins sewn into the hem of each Dole bag.

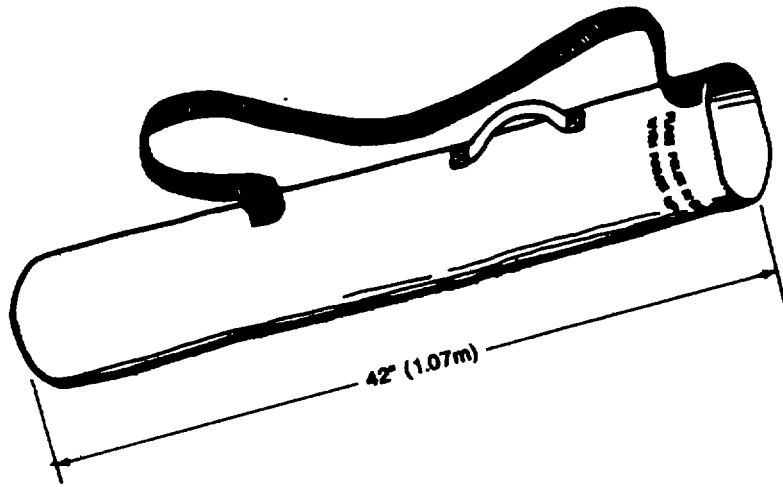

i LIGHT BAG The light bag is used to carry 72 lights and 70 signs. It is carried over the shoulder and has compartments both front and back

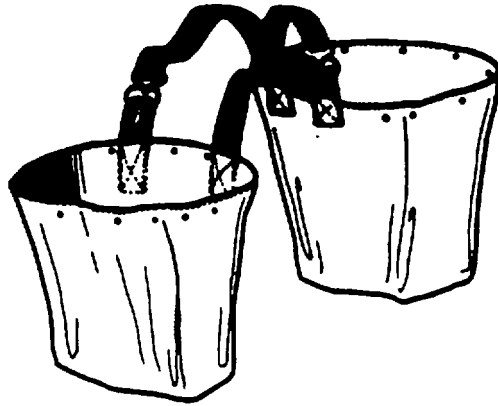

1-10

DR-8 REEL WITH RL-39 REEL ASSEMBLY.

A standard Army DR-8 reel and a standard RL-39 reel assembly are used. The reel assembly consists of a winding device and carrying straps. The carrying straps are adjustable. A new reel of tape can be inserted by removing the cotter pin and then the handle of the winding device. The new reel is then inserted in the winding device. The handle of the winding device is inserted through the winding device and reel and the cotter pin is then reinserted.

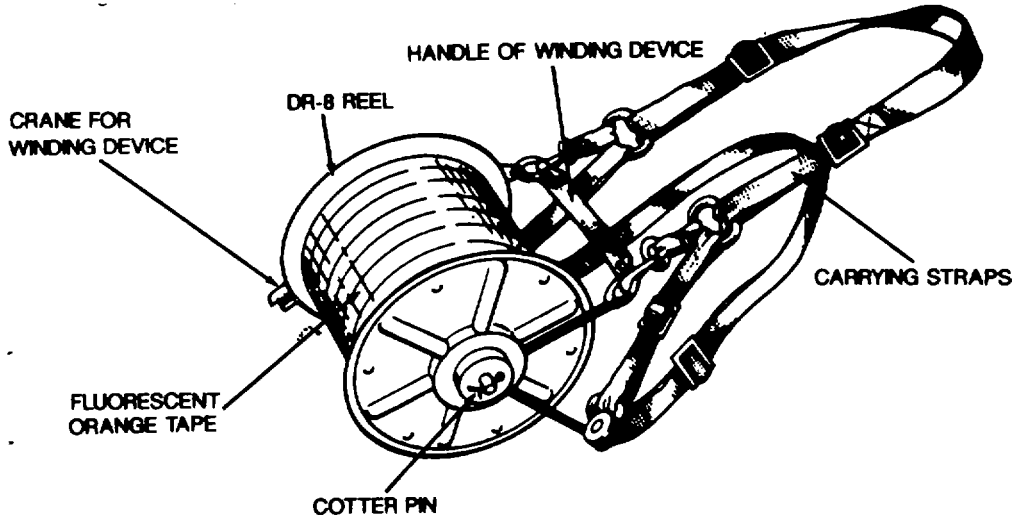

k. SIGNS. The sign is made from red vinyl reinforced with nylon webbing. The standard NATO size and colors are used. The sign fastens over the tape and then to itself with hook and pile fasteners.

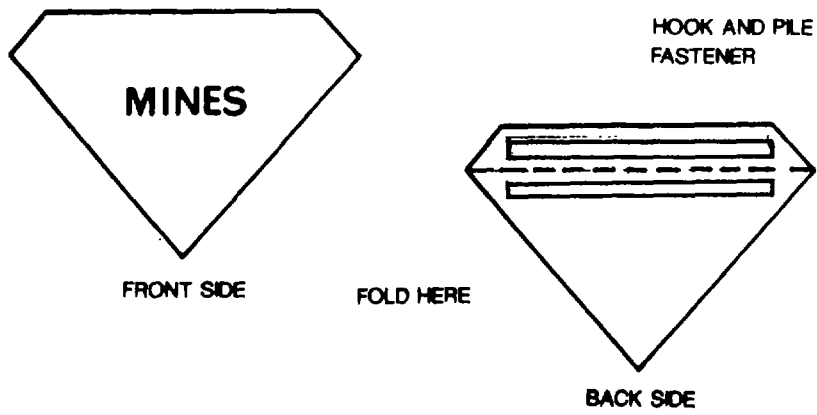

CHAPTER 2

OPERATING INSTRUCTIONS

SECTION I. PREVENTIVE MAINTENANCE

CHECKS AND SERVICES (PMCS)

2-1. GENERAL.

- a. This section provides preventive maintenance checks and services (PMCS) applicable to the HEMMS
- b. Before, during and after operation of HEMMS, be sure to keep in mind all CAUTIONS and WARNINGS
- c. Should your equipment fail to operate, refer to repair instruction on page 3-4 and 3-5. Report any deficiencies using proper forum (see TM 38-750)

2-2. PMCS PROCEDURES.

- a. The HEMMS requires no inspection or maintenance upon receipt.
- b. Before and during PMCS are listed in the following table.

OPERATOR'S PREVENTIVE MAINTENANCE CHECKS AND SERVICES (PMCS)-

NOTE: Within designated interval, these checks are to be performed in the order listed.

B - Before
D - During

A - After
W - Weekly

M - Monthly

ITEM NO	INTERVAL					Items to be Inspected	Procedures. Check for and have repaired or adjusted as necessary	For readiness reporting. Equipment is not ready/ not available if:
	B	D	A	W	M			
1	•					Batteries	Inspect batteries for corrosion. Do not use corroded batteries, check date on battery to determine if it is fresh.	
2	•					Flasher	Unscrew flasher assembly from light case. Insert	

**OPERATOR'S PREVENTIVE MAINTENANCE CHECKS AND SERVICES (PMCS)-
Continued**

ITEM NO	INTERVAL					Items to be Inspected	Procedures. Check for and have repaired or adjusted as necessary	For readiness reporting. Equipment is not ready/ not available if:
	B	D	A	W	M			
3	•					HEMMS	<p>battery. Screw flasher assembly back onto case. After inserting battery in each light, check to see that light flashes. If light flashes abnormally slow (it should flash approximately 88 flashes/minute at 70°F), replace battery with fresh</p> <p>If set has been used before, inspect driving surface of pole driver to see if it is peened. If it is peened so that a pole does not slide easily inside it, file off</p>	

OPERATOR'S PREVENTIVE MAINTENANCE CHECKS AND SERVICES (PMCS)
Continued

ITEM NO	INTERVAL					Items to be Inspected	Procedures. Check for and have repaired or adjusted as necessary	For readiness reporting. Equip- ment is not ready/ not available if:
	B	D	A	W	M			
							peened area with round file. If no file is available, use a driver from another set.	

OPERATOR'S PREVENTIVE MAINTENANCE CHECKS AND SERVICES (PMCS)
Continued

ITEM NO	INTERVAL					Items to be Inspected	Procedures. Check for and have repaired or adjusted as necessary	For readiness reporting. Equipment is not ready/ not available if:
	B	D	A	W	M			
4		•				HEMMS	<p>If the set is used beyond the life of the battery (see page 2-34) replace all batteries in the lights</p> <p>If any light flashes at a rate less than 65 flashes per minute, replace its battery.</p> <p>If the lights fail and there are spare lights available, they may be replaced as required.</p> <p>After stormy wind, reorient lights if they should vibrate out of position, splice any breaks in barrier tape and reset any poles in an upright position.</p>	

SECTION II. OPERATION UNDER USUAL CONDITIONS

2-3. ASSEMBLY AND PREPARATION FOR USE. UNPACKAGING

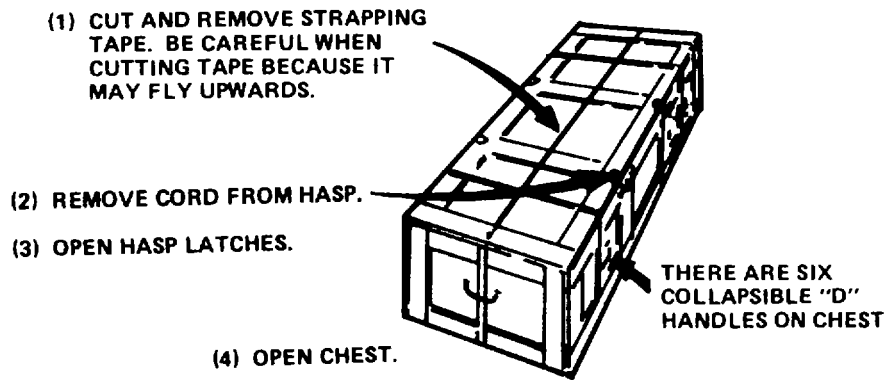

(5) If set has been previously used, check to see that the following components are in set:

- (a) 1 Box of lights (72)
- (b) 2 Bags of poles (35 per bag)
- (c) 2 Packages of signs (35 per package)
- (d) 1 DR-8 reel filled with tape
- (e) 1 Reel of tape with winding device and carrying straps
- (f) 1 Pole driver
- (g) 1 Light Bag
- (h) At least 1 drive plate

NOTE

Set may be used until depleted 50% then cannibalize.

(6) If set has been previously used, obtain 72 cells per set from stock. If temperature is expected to remain above 0°F (017.8°C), use BA30 (NSN 6135-00-120-1020). If temperature is expected to drop below 0°F (-17.80C), use BA3030/U (NSN 6135-00-930-0030). Under any temperature BA3030/U may be used.

(7) Open box of batteries.

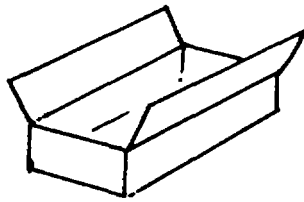

(8) Remove light box from vapor proof bag Store vapor proof bag in chest.

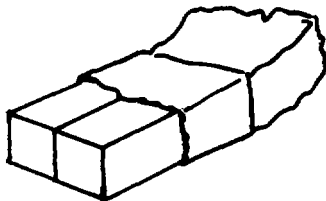

(9) Open the box of lights. Place one battery in each light (the battery is installed it and flat). 8crew the flasher assembly down handtight and check to see that the light flashes If the light does not flash, unscrew the flasher assembly and determine if the battery b Installed correctly.

(10) Place lights In light box. Repack fight box into chest.

NOTE

If the met is not to be emplaced within 8 hours loosen the dome to the point where the light does not flash, prior to repacking in the light box

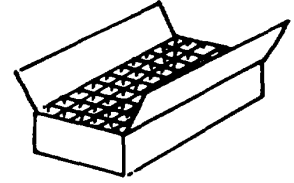

(11) Throw away box that batteries came in.

(12) Load chest onto truck. Since the set weighs 174 pounds (79.0 kg), four men are needed to lift set onto a 5 ton (4540 kg) cargo truck and all other trucks with a bed height of no more than 54 inches (1.37 m). For higher lifts the box of lights should be removed from set and loaded separately.

(13) Drive to minefield.

(14) Unload chest from back of truck if necessary; otherwise open chest and hand individual components of set to men on ground. Do not drop chest from back of truck.

(15) When carrying cheat to edge of minefield, use four men.

2-4. OPERATING PROCEDURE - EMPLOYMENT OF HEMMS.

a. Upon arrival at minefield, unload the HEMMS8 follows:

- (1) UNLOAD CHEST FROM BACK OF TRUCK.
- (2) CARRY CHEST TO EDGE OF MINEFIELD USING FOUR MEN.
- (3) REMOVE ALL COMPONENTS FROM CHEST.

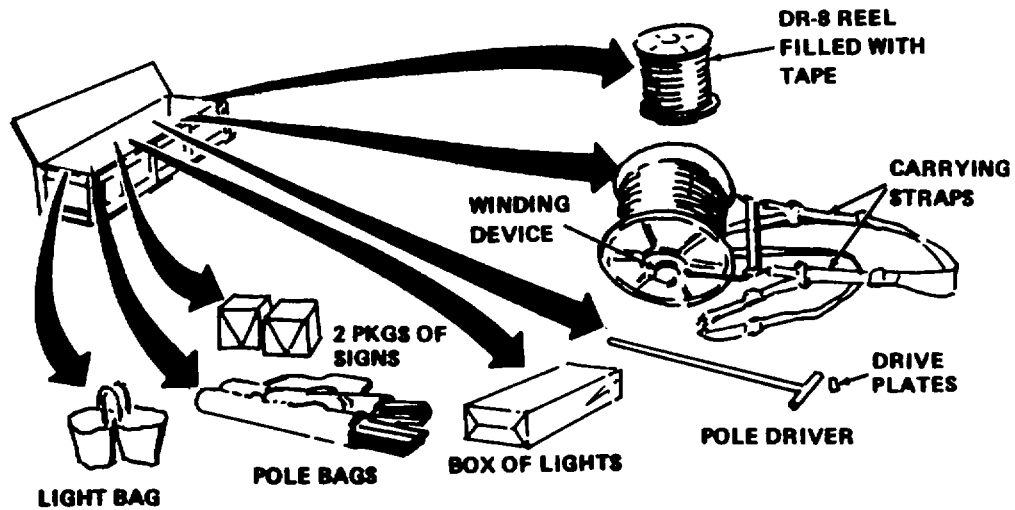

(5) PUT ONE PKG OF SIGNS
IN EACH LIGHT BAG.

(4) PUT LIGHTS IN LIGHT BAG.
DISTRIBUTE THE LIGHTS
EQUALLY BETWEEN THE
TWO SECTIONS OF THE BAG.

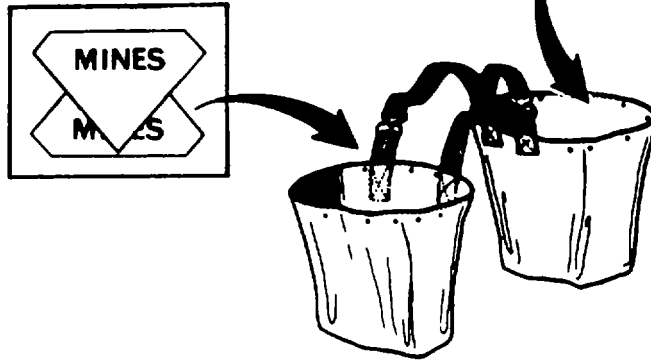

b. DUTIES OF TEAM MEMBERS.

WARNING

Always carry poles with points pointing forward to prevent injury.

- (1) POLE CARRIER. Carry extra bag of poles. Relieves the pole driver as directed by the squad leader.
- (2) POLE EMPLACER. Carry bag of poles. Space them required distances apart.
- (3) POLE DRIVER. Drive poles into ground. Trades off with pole carrier when fatigued.
- (4) TAPE CARRIER. Unwind tape. Tie tape to poles.
- (5) LIGHT PLACER. Places lights in poles. Attaches signs to tape.
- (6) SQUAD LEADER. Supervises emplacement. Carry Operator's Manual.

TEAM MEMBERS

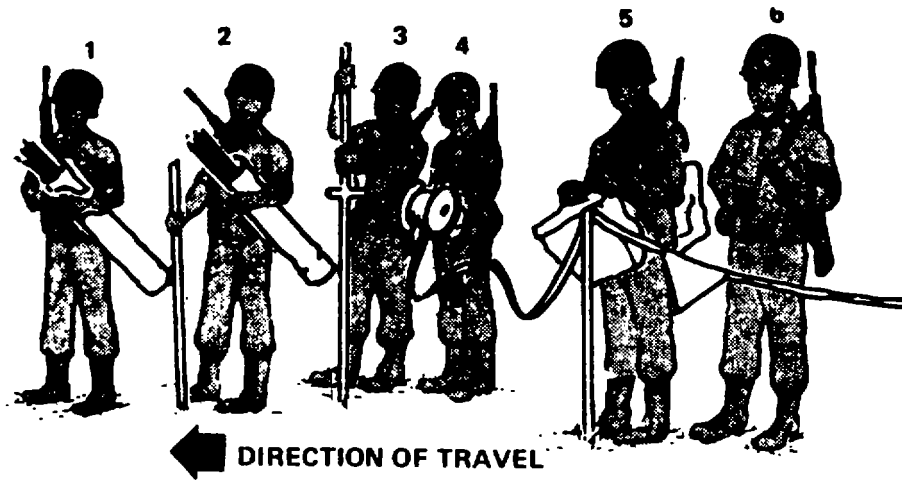

c. PREPARATION FOR EMPLACEMENT.

The HEMMS is emplaced by six men. They must prepare them selves before emplacing HEMMS.

(1) **POLE CARRIER.** Helps tape carrier adjust straps. Puts bag of poles over head. Points poles forward. Relieves pole driver as required;

(2) **POLE EMPLACER.** Helps light emplacer adjust straps. Puts bag of poles over head. Points poles forward.

(3) **POLE DRIVER.** Unties bag of drive plates from pole driver and removes one drive plate. Puts on gloves preferably leather. Gets pole driver.

(14) **TAPE CARRIER.** Puts harness on, Adjusts to fit comfortably by moving slide fastener on neck strap and side strap.

(15) **LIGHT PLACER.** He places light bag over his head. He adjusts straps to fit comfortably.

(6) **SQUAD LEADER.** Oversees preparation. Carry Operator's Manual.

EMPLACEMENT OF POLES



- (1) Determine pole spacing. Poles should be placed 17 paces (30 inch pace) apart where the tape is unprotected from the wind. If the tape is protected from the wind, such as in a tree line or thick brush, place poles 24 paces apart. If the pole can be easily pushed all the way into the ground using the technique "soft ground" on page 2-16 use 10 paces between poles. See page 2-23 for safe lane dimensions.

WARNING

Never stand or place pole within 66 ft (20 m) of emplaced mine.

- (2) Pace off distance between poles.
- (3) Select site, avoiding rocks and swampy spots. Avoid placing poles such that the tape would rub against tree limbs and sharp objects.
- (4) Remove pole from bag. Exercise care when removing poles from pole bag so as not to hit anyone with points.
- (5) Drive pole by hand into soil if possible. Otherwise lay pole on ground.

e. DRIVING POLES INTO GROUND.

(1) IN SOFT GROUND.

- (a) Place pole driver ("T" end first) over top of pole until "T" end rests on groove pin.
- (b) Press down with foot on the pole driver "T" end until the groove pin reaches ground level

WARNING

Do not jump on or place both feet on driver when pushing pole into ground. Otherwise you may bend pole or injured yourself on the pole if you miss the driver.

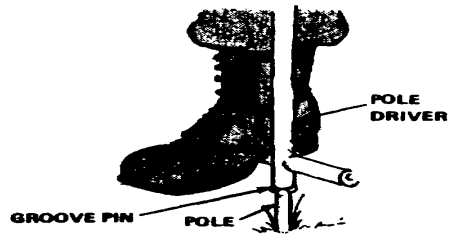

(2) IN HARD GROUND

- (a) Place drive plate down over pole.
- (b) Place pole driver over pole with "T" end down.
- (c) Lift pole driver and ram it against the drive plate.

Repeat until groove pin is one inch above ground level. However if the soil is frozen and the soldier believes that it will not thaw while poles are in place, stop driving after 40 blows. Leave groove pin 1 inch above ground level.

- (d) Remove drive plate to use on next pole.
- (e) After driving in 70 poles or as directed by the squad leader, trade off duties with pole carrier.



f. EMLACING TAPE.

(1) Tie the tape to first pole. If it is a corner pole tie a clove hitch beneath groove pin at the base of the pole (see page 2-22). If it is any other pole unroll about 7-1/2 ft (2 m) of tape and then tie tape to pole using double wrap tie shown on page 2-19. Wrap the tape at least 2 turns around the pole, pull the tape through the slot in the direction of travel and wrap the tape at least 2 turns more around the pole.

CAUTION

If tape is not wrapped as described above it will tear on edge of slot in pole. Be sure that the tape approaches the pole and the tape leaves the pole on the same side (see fig. on page 2-19).

(2) Walk forward (never backwards) to next pole. Guide tape with one hand to prevent it from entangling on reel handle.

(3) After reaching second pole, leave enough slack in tape so that tape droops about 2 inches (50.8 cm) midway between poles.

(4) Tie tape to second pole, again using double wrap tie.

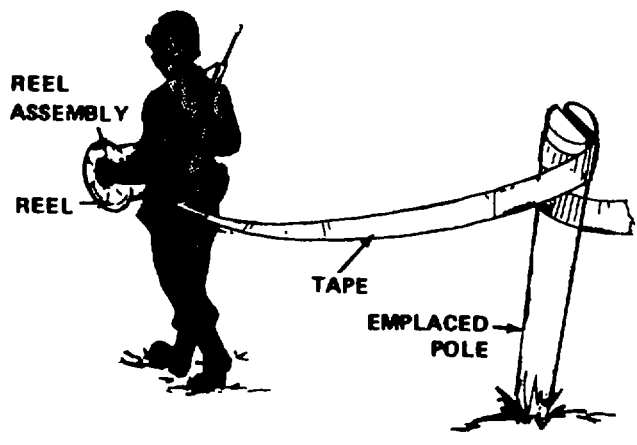

EMPLACING TAPE

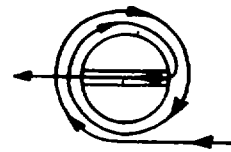

FIRST STEP

DOUBLE WRAP TIE

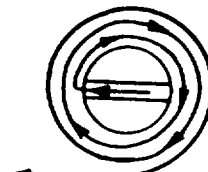

SECOND STEP

g. EMPLACING LIGHTS AND SIGNS.

(1) Light man takes light from bag.

(2) Place flashing light on top of pole. Peg must be forced all the way down into pole. Place lights to front away from minefield so that anyone approaching can see them.

(3) After emplacing about 18 lights, turn bag around and remove lights from other half of bag. After removing all 36 lights turn bag around again and use remaining lights.

(4) Midway between pole except the corner ones., remove a sign from bag. Place sign over tape. Fold sign back on itself so that hook and pile strips stick to each other. Firmly press hook and pile strips together. The word "MINES" faces away from the minefield

(5) Quick release fasteners have been provided on bag to make it possible to drop bag quickly. To remove bag quickly, turn fastener on strap 90° and pull one part of fastener through the other.



h. LAYOUT OF CORNERS.

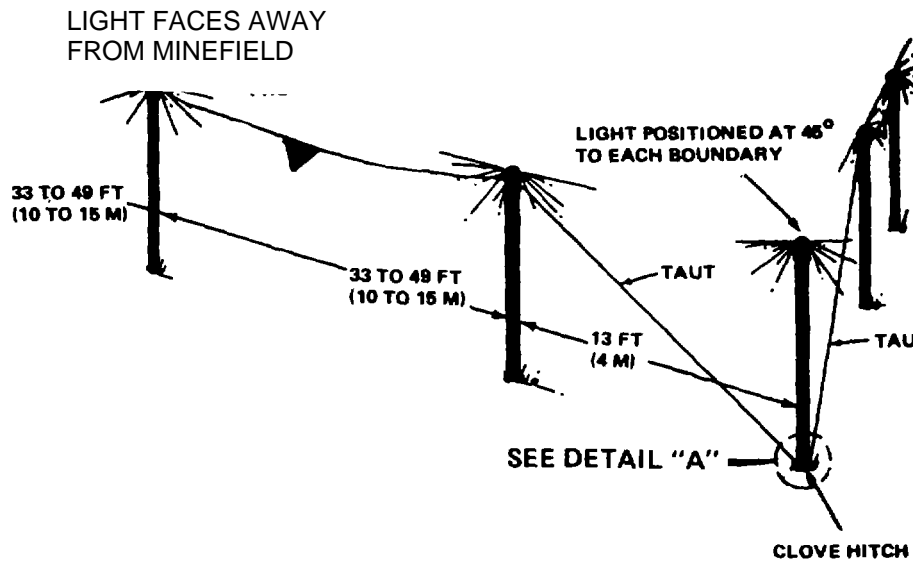

IT IS NECESSARY TO ANCHOR AT EACH CORNER POST AS SHOWN ABOVE. THE LINE IS TIED TO CORNER POLE JUST BELOW GROOVE PIN WITH A CLOVE HITCH. SPACE THE POLES ON EITHER SIDE OF THE CORNER POLE 13 FT (4 M) FROM THE CORNER POLE. ALL OTHER POLES WILL BE SPACED 33 TO 49 FT (10 TO 15 M) APART.

h. LAYOUT OF CORNERS - continued

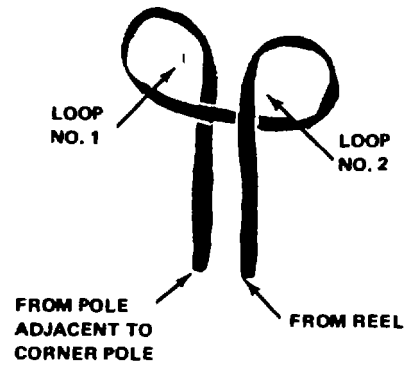

PROCEDURE FOR TYING TAPE AT CORNER POLE: AFTER MAKING THE TWO LOOPS (AS SHOWN) PLACE ONE FINGER THROUGH THE BOTTOM OF LOOP 2 AND THEN THROUGH THE BOTTOM OF LOOP 1. NOW PLACE THE LOOPS OVER THE CORNER MARKER POLE BELOW THE GROOVE PIN AND BE SURE THERE IS TAPE TENSION FROM THE POLE ADJACENT TO THE CORNER POLE BY ADJUSTING THE LOOP.

LAYOUT OF SAFE LANE.

NOTE

Safe lanes are 8 meters wide for one way vehicle traffic and 16 meters wide for two-way traffic. The marker pole may be used to measure the width of the safe lane. Six (6) pole lengths are approximately equal to 8 meters.

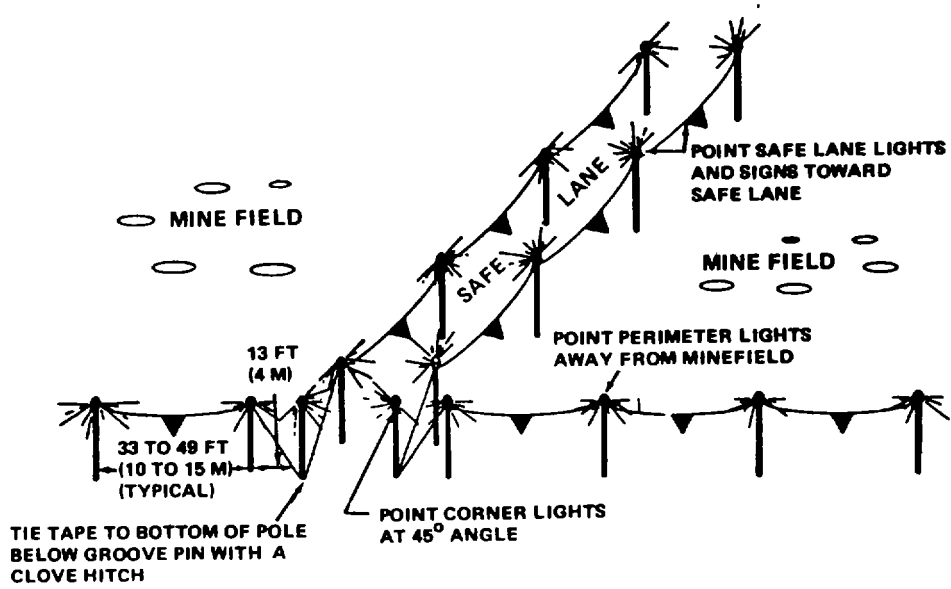

2-5. OPERATING PROCEDURE - RECOVERY OF HEMMS.

a. TO RECOVER LIGHTS AND SIGNS.

(1) REMOVE LIGHT FROM EACH POLE BY TWISTING LIGHT AND LIFTING IT UPWARDS.

(2) IF SET IS RECOVERED AT NIGHT TROOPS MAY WANT TO SHUT OFF LIGHTS. IF SO UNSCREW FLASHER ASSEMBLY UNTIL LIGHT STOPS FLASHING. OTHERWISE LEAVE LIGHT FLASHING.

(3) PLACE LIGHT INTO LIGHT BAG.

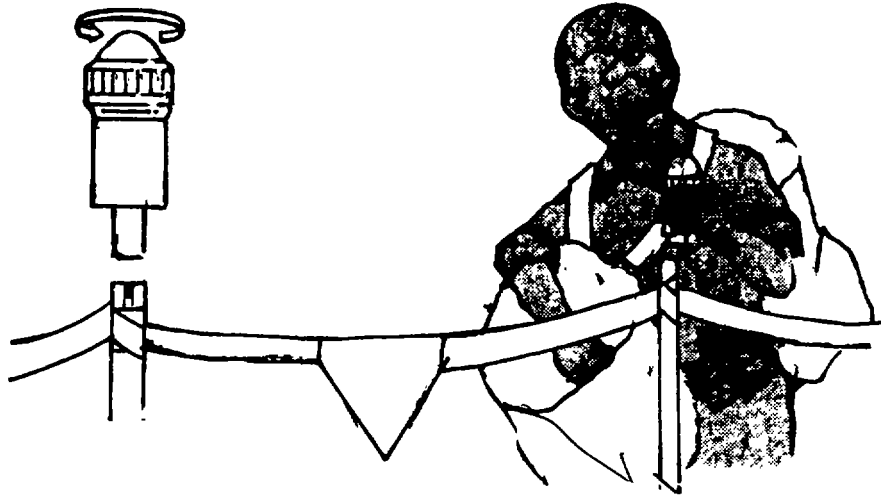

WARNING

Do not retrieve set around a scatterable minefield during the period when mines may self destruct.

(5) PLACE SIGN INTO LIGHT BAG.

b. REMOVAL OF POLES.

**(1) REMOVE TAPE FROM EACH POLE BY LIFTING
TAPE OUT OF POLE SLOT.**

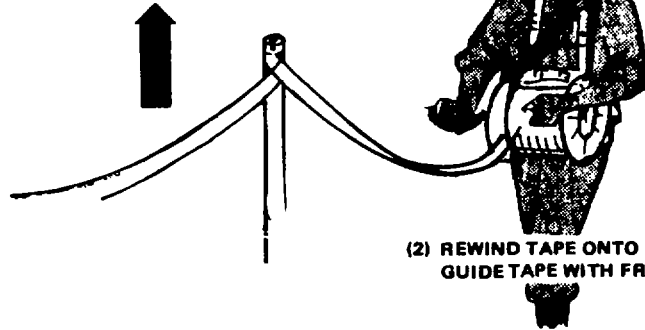

**(2) REWIND TAPE ONTO REEL.
GUIDE TAPE WITH FREE HAND.**

c. RECOVERY OF TAPE.

(1) POLE DRIVER SHALL REMOVE POLES BY PLACING THE SLOTTED END OF THE POLE DRIVER ("T" END UP) OVER EACH POLE AS SHOWN BELOW.

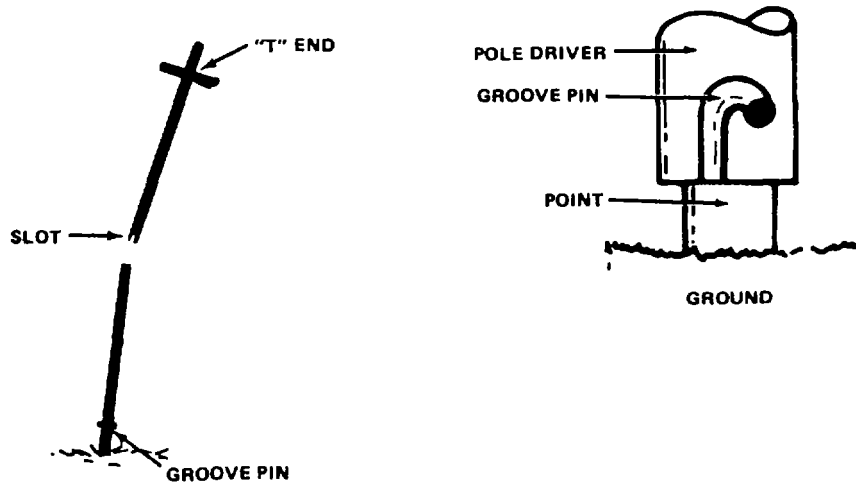

(2) PUT THE SLOT AROUND THE GROOVE PIN. THE GROOVE PIN MUST FIT UP ALL THE WAY INTO SLOT AS SHOWN ABOVE, IF SOIL IS FROZEN AROUND GROOVE PIN, FIRST LOOSEN SOIL BEFORE RETRIEVING POLE OR LEAVE POLE IN GROUND.

c. REMOVAL OF POLES - continued

(3) USING THE "T" END OF THE POLE DRIVER AS A HANDLE - ROTATE THE DRIVER CLOCKWISE ABOUT 90 DEGREES. IN HARD FROZEN SOIL ROTATE DRIVER SEVERAL TIMES.

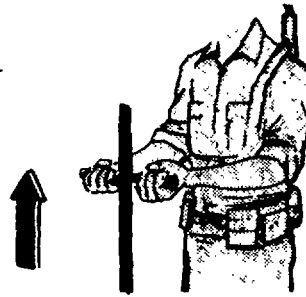
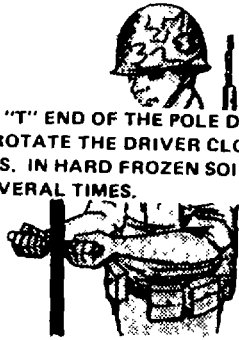

(4) AT THE SAME TIME LIFT THE "T" END HANDLE. THIS FORCE WILL REMOVE POLE. DO NOT PUSH POLE SIDWAYS IN AN EFFORT TO LOOSEN POLE BECAUSE THIS WOULD BEND THE POLE.

(5) LAY POLE ON GROUND OR HAND POLE TO POLE EMPLACER.

(6) WHEN WORKING IN HARD GROUND TRADE OFF WITH POLE CARRIER.

d. PICKING UP POLES.

- (1) The pole emplacer will pick up pole and place it in bag, point end up.
- (2) Put 35 poles in bag
- (3) After picking up 35 poles, pick up remainder of poles and place them in second bag.

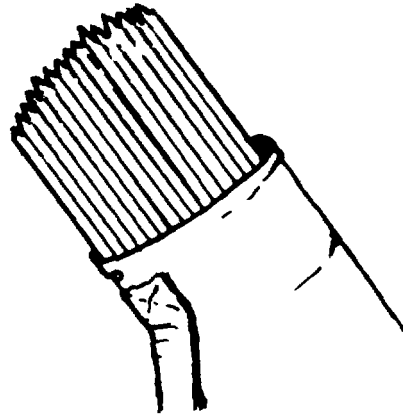

e. REPACKING OF HEMMS. (FIELD AND FINAL REPACKING)

After recovery of the marking set in the field arrange everything in the chest as nearly as possible to original position. Lights may be left in light bag and packed in chest until soldiers return from mission. Upon returning from mission, remove the light from light bag, remove and discard batteries. Screw lens on light down tight against seal. Replace light in light box. (If light box is unusable or lost, place light in light bag. Close fasteners on light bag. Pack foam so the Lid holds bag of lights in place.)

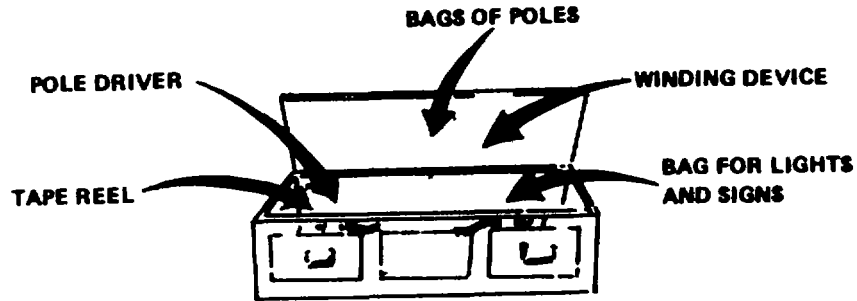

NOTE

The marking set may be reused as a set until there are not enough parts to mark 1303 feet (400m) of fence. Partial sets can be combined to make full sets. Just before reusing set install new batteries in lights (see page 3-1).

Change 2 2-29

f. FIELD REPACKING DIAGRAM

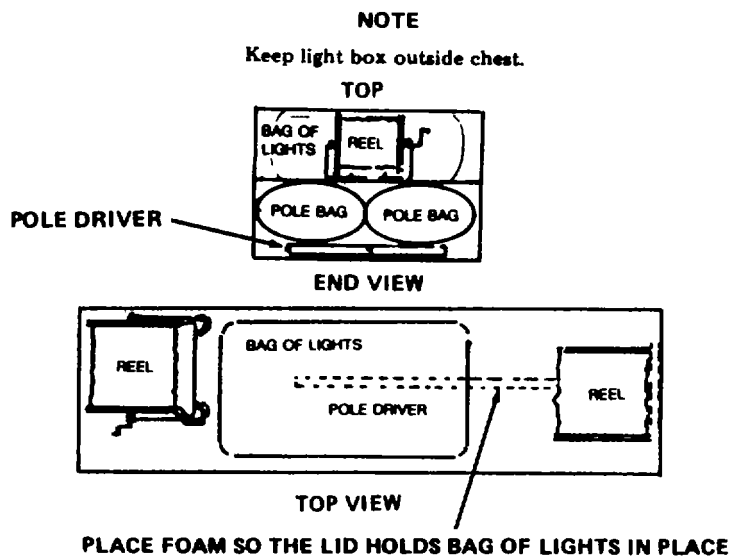

FINAL REPACKING DIAGRAM.

CAUTION

Upon return from mission, remove and discard batteries from lights, and repack set as shown

NOTE

Light bags will be folded and placed on top of light box.

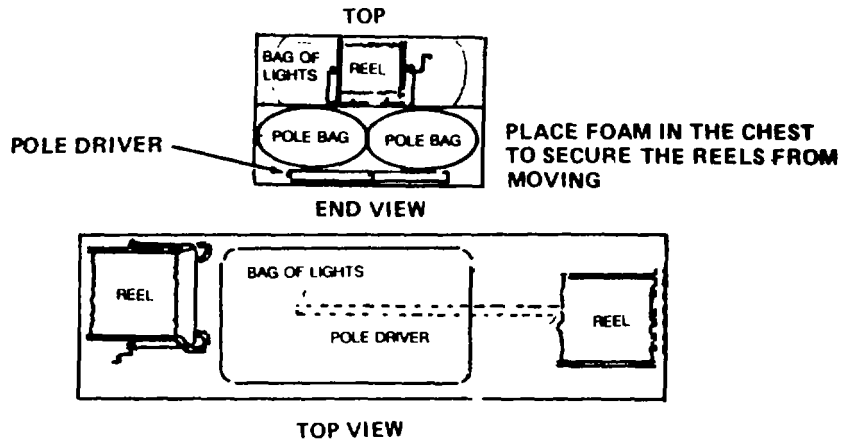

SECTION III. OPERATION UNDER UNUSUAL CONDITION

2-6. OPERATION IN UNUSUAL WEATHER.

The light will flash for a long time on a single battery.

The time will depend on the battery used, freshness, and temperature. The light will flash approximately the number of days shown:

BATTERY TYPE	EXPECTED DAYS OF OPERATION			
	-16°F (-27°C)	0°F (-18°C)	70°F (21°C)	100°F (38°C) ESTIMATED
BA3030U NSN 6135-00-930-0030	22 days	29 days	69 days	65 days
BA30 NSN 6135-00-120-1020	Not used	25 days	56 days	53 days

If there are strong winds combined with very soft soil, it might be necessary to put one or more poles back up straight. If there are strong winds combined with cold weather it will be necessary to tie the tape back together also check to see that lights are in poles pointed away from minefield, and are pushed all the way down into the poles.

CHAPTER 3
MAINTENANCE INSTRUCTIONS

3-1. GENERAL. This chapter contains information for the maintenance and repair of the HEMMS.

3-2. BATTERIES.

a. INSPECTION.

NOTE

Batteries are not issued with the HEMMS. Using units will be responsible for ordering and rotating stocks of batteries.

(1) BEFORE USE.

- (a) Inspect dry cells for corrosion. Check date on dry cell to determine if *frsh*. A fresh cell is one that is used within 9 months of date stamped.
- (b) Insert cell in each light to be sure light fln he. If light flashes abnormally slow (less than 65 flashes/min at 700F (21oC)), replace with fresh cell

(2) DURING MISSION. Perform flash check to be sure set has not been used beyond life of the cells (see page 3-3). If lights fail to flash properly or otherwise malfunction, replace cells.

(3) AFTER USE. Note flash rate of lights. If lights flash less than 65 flashes per minute at 70°F (21°C), throw cells away. Otherwise, cells may be reused in other uses.

CAUTION

Used batteries should never be left in the HEMMS during storage. Leakage and corrosion from used batteries could severely damage the set.

b. REPAIR. If batteries must be replaced, simply discard old battery and insert a new one.

c. CELL LIFE OF BATTERIES. The light will flash for a long time on a single cell. The time will depend on the cell used, how fresh the cell is, and ambient temperature. The lights were designed to flash for a minimum of the number of days shown:

Average Outside Temperature			
16°F (-27°C)	0°F (-18°C)	70°F (21°C)	100°F (38°C) (estimated)

BA3030 U NSN 6135-00-930-0030	22 days	29days	69days	65 days
BA30 NSN 6135-00-120-1020	Not used	25days	66days	53 days

3-3. LIGHTS.

a. INSPECTION.

(1) BEFORE USE. Check to be sure light flashes. If light fails to flash, first replace battery. If light still does not flash, refer to paragraph 3-3b, page 3-4.

(2) DURING MISSION. If lights should fail and spare lights are available, they may be replaced as required.

(3) AFTER USE. Follow same procedure as in (1) above.

b. REPAIR.

(1) If the light do not flash do the following: Replace cell. If it still does not flash, remove contact spring and check for corrosion. Remove any corrosion and reassemble..

(2) If light still does not function, replace light.

3-4. TAPE.

a. INSPECTION. Check to be sure tape is not stretched, worn or broken.

b. REPAIR.

(1) If tape should break, it can be repaired by tying it together with a square knot.

(2) If tape is badly stretched or has been tied in too many places, discard bad portion.

5. POLES.

a. INSPECTION.

(1) Be sure that poles are straight. If in doubt, place pole driver over pole. If pole is straight, it won't bind in pole driver.

(2) Check to see if groove pins in poles are not broken or lost.

b. CLEANING. After poles are removed from ground, clean off all dirt and debris.

c. REPAIR.

(1) If poles are severely bent, they should be replaced. If only the tips are bent, they can be hammered back into shape.

(2) If groove pins in pole are broken, they should be replaced. To replace groove pin, refer to the following steps:

(a) Cut about two inches (51 mm) of stitching from upper seam of pole bag.

(b) Remove groove pin (2 in each bag).

(c) Hammer new groove pin into hole in point.

(3) If poles should fall over during mission, place them upright and drive into ground.

3-6. POLE DRIVER. Inspect driving surface of pole driver. If it is peened, file off excess material with round file.

3-7. SIGNS. Replace signs as required.

3-8. MAINTENANCE.

- a. The HEMMS requires no inspection or maintenance upon receipt.
- b. No maintenance is required when HEMMS is in storage. Always store the HEMMS in its chest in a dry area.
- c. Before each use.

(1) When operations are planned involving use of HEMMS, obtain batteries through normal supply channels. See page 3-3 for stock numbers.

(2) Inspect batteries for corrosion. Do not use corroded batteries. Check date on batteries to determine if it is fresh.

(3) Unscrew flasher assembly from light case. Insert battery. Screw flasher assembly back onto case. After inserting battery in each light, check to see that light flashes. If Light flashes abnormally slow (it should flash approximately 88 flashes/minute at 70°F), replace battery with fresh battery.

NOTE

Do not use excessive force when screwing flasher assembly to light case.

(4) If set has been used before, inspect driving surface of pole driver to see if it is peened. If it is peened so that a pole does not slide easily inside it, file off peened area with round file. If no file is available, use a driver from another set.

(5) Adjust the reel assembly straps to fit the soldier. If the reels on reel assembly are beyond repair and are not available in another set they may be ordered through supply.

(6) If any of the bags are torn, sew it together.

(7) The marking set may be reused as a set until depleted approximately 50%. Partial set can be combined to make full set.

(8) If pole tips are bent they should be hammered back into shape. If both ends of groove pin should break or if the groove pin should be lost replace groove pin. Cut 2 inches of stitching from upper seam of pole bag. Remove groove pin, hammer groove pin into hole in point.

(9) If the tape should break, tie ends together with a square knot. If tape is badly stretched or has been tied in many places, discard bad portion.

(10) A new reel of tape can be inserted by removing the cotter pin and then the handle on the winding device. The new reel is then inserted in the winding device. The handle of the winding device is inserted through the winding device and reel and the cotter pin is then reinserted.

**APPENDIX A
REFERENCES**

DA PAM 738-750	The Army Maintenance Management System (TAMMS)
SC 9905-97-CLE02	Sets, Kits and Outfits Components List, Minefield Marking Set, Hand Emplaceable, MI 33
SC 9905-97-CL-E02HR	Hand Receipt Catalog, Minefield Marking Set, Hand Emplaceable, M133

A-1/(A-2 Blank)

**APPENDIX B
COMPONENTS OF END ITEM AND BASIC ISSUE ITEMS LISTS**

SECTION I. INTRODUCTION

B-1. SCOPE

This appendix lists components of end item and basic issue items for the Hand Emplaceable Minefield Marking Set (HEMMS) to help you inventory items required for safe and efficient operation.

B-2. GENERAL

The Components of End Item and Basic Issue Items Lists are divided into the following sections:

a. Section II. Components of End Item. This listing is for informational purposes only, and is not authority to requisition replacements. These items are part of the end item, but are removed and separately packaged for transportation or shipment. As part of the end item, these items must be with the end item whenever it is issued or transferred between property accounts. Illustrations are furnished to assist you in identifying the items.

b. Section III. Basic Issue Items. These are the minimum essential items required to place the HEMMS in operation, to operate it, and to perform emergency repairs. Although shipped separately packaged, BII must be with the HEMMS during operation and whenever it is transferred between property accounts. The illustrations will assist you with hard-to-identify items. This manual is your authority to request/requisition replacement BII, based on TOE/MTOE authorization of the end item.

B-3. EXPLANATION OF COLUMNS

The following provides an explanation of columns found in the tabular listings:

a. Column (1) - Illustration Number (Illus. Number). This column indicates the number of the illustration in which the item is shown.

b. Column (2) - National Stock Number. Indicates the National stock number assigned to the item and will be used for requisitioning purposes.

c. Column (3)- Description. Indicates the Federal item name and, if required, a minimum description to identify and locate the item. The last line for each item indicates the FSCM (in parentheses) followed by the part number. If item needed differs for different models of this equipment, the model is shown under the "Usable On" heading in this column.

d. Column (4) - Unit ^{9f} Measure (U/M). Indicates the measure used in performing the actual operational/maintenance function. This measure is expressed by a two-character alphabetical abbreviation (e.g., ea., in, pr).

e. Column (5) - Quantity required (Qty rqr). Indicates the quantity of the item authorized to be used with/on the equipment.

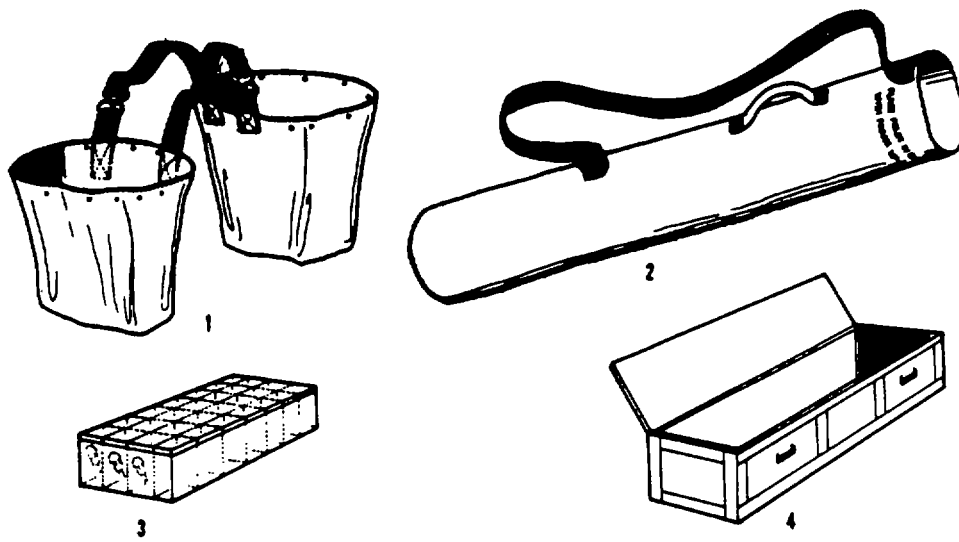

B-4

SECTION II. COMPONENTS OF END ITEM

(1) ILLUS NUMBER	(2) NATIONAL STOCK NUMBER	(3) DESCRIPTION (FSCM) and Part Number	Usable On Code	(4) U/M	(5) QTY Rqr
1	8105-01-066-9544	BAG Light (97403) 13221E7393		EA	2
2	8105-01-466-9545	Bag Pole (97403) 13221E7396		EA	2
3	6220-01-081-0593	Box Light (97403) 13221E7397		EA	1
4	8145-01-482-1132	Chest, Minefield Marking Set (97403) 13221E7397		EA	1
	8135-00-892-3917	Cushioning Material, Packing: plastic, polystyrene, 2.667 fl. nom lg O/A, 32 in. om w O/A, 1/8 i mom thk O/A		SH	2
B-5					

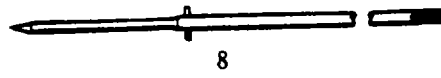
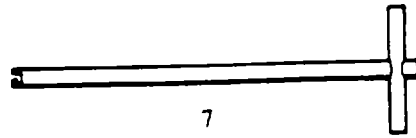

B-6

SECTION II. COMPONENTS OF END ITEM

(1) ILLUS NUMBER	(2) NATIONAL STOCK NUMBER	(3) DESCRIPTION (FSCM) and Part Number	Usable On Code	(4) U/M	(5) QTY Rqr
5	6220-01-081-0592	Light, Marking (97403) 13221E7385		EA	72
6	9905-01-066-9546	Plate, Drive (97403) 13221E7383		EA	2
7	9905-01-066-9543	Pole Driver (97403) 13221E7391		EA	1
8	9905-01-068-8638	Pole Assembly, Minefield Marking: (97403)13221E7389		EA	72
B-7					

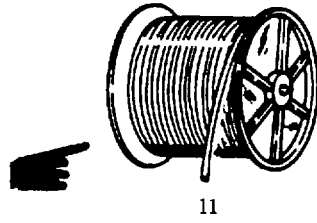

11

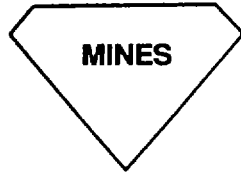

10

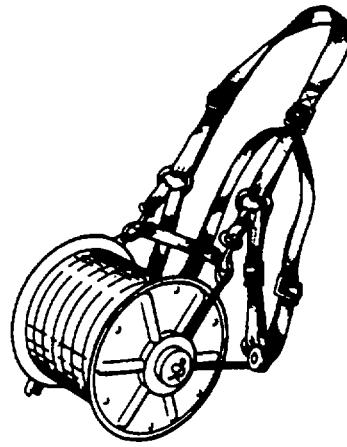

9

Change 1 B-8

SECTION II. COMPONENTS OF END ITEM

(1) ILLUS NUMBER	(2) NATIONAL STOCK NUMBER	(3) DESCRIPTION (FSCM) and Part Number	Usable On Code	(4) U/M	(5) QTY Rqr
9		Marking Tape and Reel Assembly Consisting of:		EA	1
	8130-00-407-7859	* Reel Cable (80063) SC-DL-90889		EA	2
	9390-01-066-9542	Tape, Marking (97403) 13221E7390		FT	7200
	3895-00-498-8343	Reeling Machine, Cable Hand (80063) SM-D-333571		EA	1
10	9905-01-066-9547	Sign, Minefield Marking (97403)13221E7399 TM 5-9905-200-10		EA	72
11	9525-01-031-1086	Wire, Non-electrical (96906) MS 20995AB32 Change 1 B-9		LB	1

SECTION III. BASIC ISSUE ITEMS

NOT APPLICABLE

APPENDIX C
EXPENDABLE/DURABLE SUPPLIES AND MATERIALS LIST

C-1. SCOPE.

This appendix lists expendable/durable supplies and materials you will need to operate and maintain the Hand Emplaceable Minefield Marking Set (HEMMS). These items are authorized to you by CTA50-970, Expendable Items (except Medical, Class V, Repair Parts, and Heraldic Items).

C-2. EXPLANATION OF COLUMNS.

a. Column 1 - Item Number. This number is assigned to the entry in the listing and is referenced in the narrative instructions to identify the material (e.g., "Use cleaning compound, Item 5, App. D").

b. Column 2 - Level. This column identifies the lowest level of maintenance that requires the listed item.

(enter as applicable):

C - Operator/Crew
O - Organizational Maintenance

F - Direct Support Maintenance
H - General Support Maintenance

C-1

c. Column 3 - National Stock Number. This is the National stock number assigned to the item; use it to request or requisition the item.

d. Column 4 - Description. Indicates the Federal item name and, if required, a description to identify the item. The last line for each item indicates the part number followed by the Federal Supply Code for Manufacturer (FSCM) in parentheses, if applicable.

e. Column 5 - Unit of Measure (U/M). Indicates the measure used in performing the actual maintenance function. This measure is expressed by a two-character alphabetical abbreviation (e.g., ea., in, pr). If the unit of measure differs from the unit of issue, requisition the lowest unit of issue that will satisfy your requirements.

SECTION II. EXPENDABLE/DURABLE SUPPLIES AND MATERIALS LIST

(1) ITEM NUMBER	(2) LEVEL	(3) NATIONAL STOCK NUMBER	(4) DESCRIPTION	(5) UNIT OF MEAS
1	C	6135-00-120-1020	Battery, Dry: 1.5V cylindrical, 1 terminal (83642) BA-30, 1-5/16 in. dia O/A, 2-1/4 in. h	PG
2	C	6135-00-930-0030	Battery, Dry: 1.5 V, cylindrical, 1 terminal, 1-5/16 in. dia O/A, 2-3/8 in. h (80058) BA3030U	
C-3/(C4 blank)				

By Order of the Secretary of the Army:

GORDON R. SULLIVAN
General, United States Army
Chief of Staff

Official:

MILTON H. HAMILTON
Administrative Assistant to the
Secretary of the Army
06154

DISTRIBUTION:

To be distributed in accordance with DA Form 12-25-E, block no. 1189,
requirements for TM 5-9905-200-10.

* GPO: 1996 - 406-421 (60101)

RECOMMENDED CHANGES TO EQUIPMENT TECHNICAL PUBLICATIONS



THEN... JOT DOWN THE DOPE ABOUT IT ON THIS FORM, CAREFULLY TEAR IT OUT, FOLD IT AND DROP IT IN THE MAIL!

SOMETHING WRONG WITH THIS PUBLICATION?

FROM: (PRINT YOUR UNIT'S COMPLETE ADDRESS)

DATE SENT

PUBLICATION NUMBER

PUBLICATION DATE

PUBLICATION TITLE

BE EXACT... PIN-POINT WHERE IT IS

PAGE NO.

PARA-GRAPH

FIGURE NO.

TABLE NO.

IN THIS SPACE TELL WHAT IS WRONG AND WHAT SHOULD BE DONE ABOUT IT:

TEAR ALONG PERFORATED LINE

PRINTED NAME, GRADE OR TITLE, AND TELEPHONE NUMBER

SIGN HERE:

DA FORM 2028-2 JUL 79

PREVIOUS EDITIONS ARE OBSOLETE.

P.S.—IF YOUR OUTFIT WANTS TO KNOW ABOUT YOUR RECOMMENDATION MAKE A CARBON COPY OF THIS AND GIVE IT TO YOUR HEADQUARTERS.

The Metric System and Equivalents

Linear Measure

1 centimeter = 10 millimeters = .39 inch
 1 decimeter = 10 centimeters = 3.94 inches
 1 meter = 10 decimeters = 39.37 inches
 1 dekameter = 10 meters = 32.8 feet
 1 hectometer = 10 dekameters = 328.08 feet
 1 kilometer = 10 hectometers = 3,280.8 feet

Weights

1 centigram = 10 milligrams = .15 grain
 1 decigram = 10 centigrams = 1.54 grains
 1 gram = 10 decigrams = .035 ounce
 1 dekagram = 10 grams = .35 ounce
 1 hectogram = 10 dekagrams = 3.52 ounces
 1 kilogram = 10 hectograms = 2.2 pounds
 1 quintal = 100 kilograms = 220.46 pounds
 1 metric ton = 10 quintals = 1.1 short tons

Liquid Measure

1 centiliter = 10 milliliters = .34 fl. ounce
 1 deciliter = 10 centiliters = 3.38 fl. ounces
 1 liter = 10 deciliters = 33.81 fl. ounces
 1 dekaliter = 10 liters = 2.64 gallons
 1 hectoliter = 10 dekaliters = 26.42 gallons
 1 kiloliter = 10 hectoliters = 264.18 gallons

Square Measure

1 sq. centimeter = 100 sq. millimeters = .155 sq. inch
 1 sq. decimeter = 100 sq. centimeters = 15.5 sq. inches
 1 sq. meter (centare) = 100 sq. decimeters = 10.76 sq. feet
 1 sq. dekameter (are) = 100 sq. meters = 1,076.4 sq. feet
 1 sq. hectometer (hectare) = 100 sq. dekameters = 2.47 acres
 1 sq. kilometer = 100 sq. hectometers = .386 sq. mile

Cubic Measure

1 cu. centimeter = 1000 cu. millimeters = .06 cu. inch
 1 cu. decimeter = 1000 cu. centimeters = 61.02 cu. inches
 1 cu. meter = 1000 cu. decimeters = 35.31 cu. feet

Approximate Conversion Factors

To change	To	Multiply by	To change	To	Multiply by
inches	centimeters	2.540	ounce-inches	newton-meters	.007062
feet	meters	.305	centimeters	inches	.394
yards	meters	.914	meters	feet	3.280
miles	kilometers	1.609	meters	yards	1.094
square inches	square centimeters	6.451	kilometers	miles	.621
square feet	square meters	.093	square centimeters	square inches	.155
square yards	square meters	.836	square meters	square feet	10.764
square miles	square kilometers	2.590	square meters	square yards	1.196
acres	square hectometers	.405	square kilometers	square miles	.386
cubic feet	cubic meters	.028	square hectometers	acres	2.471
cubic yards	cubic meters	.765	cubic meters	cubic feet	35.315
fluid ounces	milliliters	29.573	cubic meters	cubic yards	1.308
pints	liters	.473	milliliters	fluid ounces	.034
quarts	liters	.946	liters	pints	2.113
gallons	liters	3.785	liters	quarts	1.057
ounces	grams	28.349	liters	gallons	.264
pounds	kilograms	.454	grams	ounces	.035
short tons	metric tons	.907	kilograms	pounds	2.205
pound-feet	newton-meters	1.356	metric tons	short tons	1.102
pound-inches	newton-meters	.11296			

Temperature (Exact)

°F Fahrenheit temperature 5/9 (after subtracting 32) Celsius temperature °C

PIN: 043350-002